



# SOURCE 1

HVAC Service Parts

Commercial  
model **S1-TBSU306-S**

Programmable  
with **Humidity Control**



Optional  
accessories  
available,  
including  
Wi-Fi

## Digital Thermostat

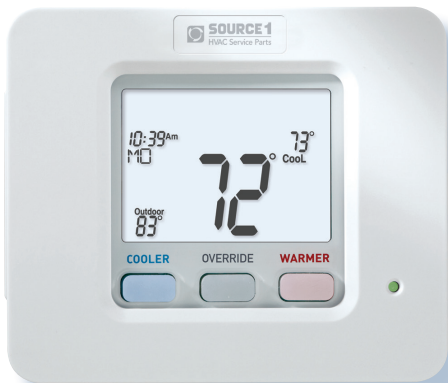

## Owner's Manual & Installation Instructions



## CAUTION

Follow the Installation Instructions before proceeding. Set the thermostat mode to “**OFF**” prior to changing settings in setup or restoring Factory Defaults.

---

This thermostat has the ability to receive updates to its firmware. Periodically firmware updates are released by the manufacturer to add features and/or performance enhancements. This manual was produced reflecting the most current firmware/feature set at the time of publication, firmware rev. 12. Firmware releases after rev. 12 may not be adequately depicted in this manual. Please refer to the appropriate website or contact your place of purchase to learn about changes to the thermostat after firmware release 12.



# Glossary of Terms

**Auto-Changeover:** A mode in which the thermostat turns on the heating or cooling based on room temperature demand.

**Cool Setpoint:** The warmest temperature that the space should rise to before cooling is turned on (without regard to deadband).

**Deadband:** The number of degrees the thermostat will wait, once a setpoint has been reached, before energizing heating or cooling.

**Dehumidify:** To reduce the amount of moisture in the air.

**Differential:** The forced temperature difference between the **heat setpoint** and the **cool setpoint**.

**Heat Setpoint:** The coolest temperature that the space should drop to before heating is turned on (without regard to deadband).

**Humidify:** To increase the amount of moisture in the air.

**Icon:** The word or symbol that appears on the thermostat display.

**Mode:** The current operating condition of the thermostat (i.e. Off, Heat, Cool, or Auto).

**Non-Programmable Thermostat:** A thermostat that does not have the capability to run **Time Period Programming**.

**Override:** During programmed unoccupied periods, pressing the Override button will force the thermostat into occupied settings. During programmed occupied periods, pressing the Override button will force the thermostat into unoccupied settings.

**Programmable Thermostat:** A thermostat that has the capability of running **Time Period Programming**.

**Reheat:** Runs the cooling and 2nd stage strip heaters at the same time in order to **dehumidify** the air without significantly cooling down the room temperature.

**Time Period Programming:** A program that allows the thermostat to automatically adjust the **heat setpoint**, or **cool setpoint**, based on the time of the day.

# Table of Contents

## GET TO KNOW YOUR THERMOSTAT

Get to Know Your Thermostat.....	1
Quick Start .....	6

## INSTALLATION INSTRUCTIONS

Installation Instructions .....	9
Sample Wiring Diagrams.....	13
Test Operation.....	16

## USER SETUP

Backlight Operation.....	17
Scrolling Display Options .....	18
Holiday .....	19
Emergency Heat .....	19
Wireless Module .....	20
Service Filter .....	22
Runtimes .....	23
Time Period Programming .....	24

## INSTALLER SETUP

Setpoint Limits.....	26
Timers and Deadbands .....	27
Programming Fan Operation.....	28
Comfort Recovery Operation .....	28
Humidification & Dehumidification .....	29
Dry Contact Operation .....	30
Remote Sensor Operation.....	31
Auxiliary Output .....	32
ADR .....	34
Locking/Unlocking the Keypad.....	39
Factory Defaults.....	40

## TECHNICIAN SETUP

Sensor Calibration .....	41
Equipment Testing .....	41
Advanced Setup Table .....	42
Troubleshooting .....	45

WARRANTY .....	46
----------------	----

TECHNICAL SPECIFICATIONS.....	47
-------------------------------	----

# Get To Know Your Thermostat

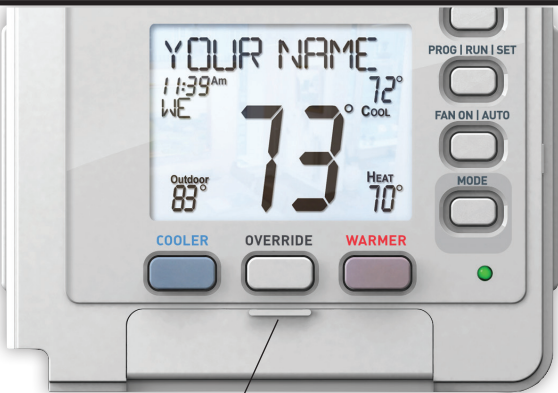
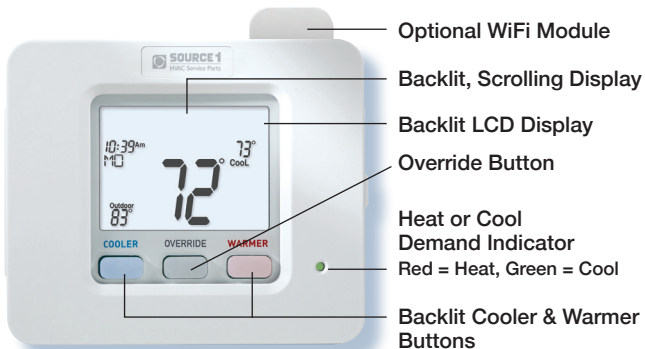

# Get To Know Your Thermostat



Setup Buttons

# Get To Know Your Thermostat

## Display Features

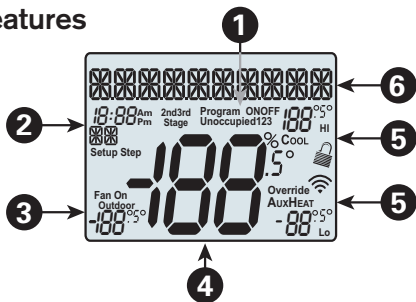

- 1 Program icon**—Indicates that Time Period Programming is running or is enabled to be set.
- 2 Clock with Day of the Week**—Indicates the current time and day. This clock is also used to program the time period schedules.
- 3 Outdoor icon**—Indicates the temperature displayed is from the optional outdoor sensor.
- 4 Room Temperature Display**—Indicates the **current** room temperature and displays the outdoor temperature when selected.
- 5 Mode Indicators**  
Selects the operational mode of the equipment.
  - HEAT** - Indicates the heating mode.
  - COOL** - Indicates the air conditioning mode.
  - HEAT & COOL** - Indicates the system will automatically change-over between heat and cool modes as the temperature varies.
  - OFF** - Indicates heating and cooling are turned off.
- 6** The scrolling display will be used to help you easily navigate the setup screens in the thermostat.

# Get To Know Your Thermostat

## Display Features

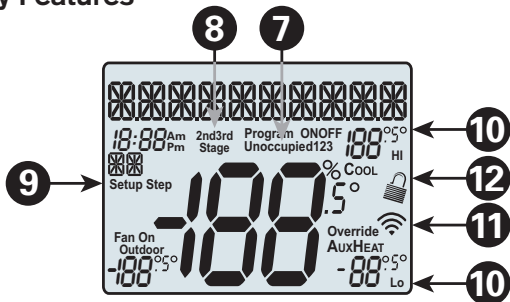

- 7 Occupied & Unoccupied icons**—Indicates the program number: Occupied 1, 2, 3 or Unoccupied
- 8 2nd and 3rd Stage icons**—Indicates what stage of cooling or heating is currently energized.
- 9 Setup Step icon**—Indicates the step number when the thermostat is in the setup mode.
- 10 Desired Set Temperature**—Indicates **desired** room temperature(s). Also displays the highest and lowest temperatures for the day.
- 11 Wi-Fi icons**—One dot indicates the thermostat recognizes the wireless module. The **full** icon indicates the thermostat is currently connected to the Local access point, via the optional Wi-Fi Module.
- 12 Lock icon**—Indicates the keypad has been locked.



# Get To Know Your Thermostat

## Display Features

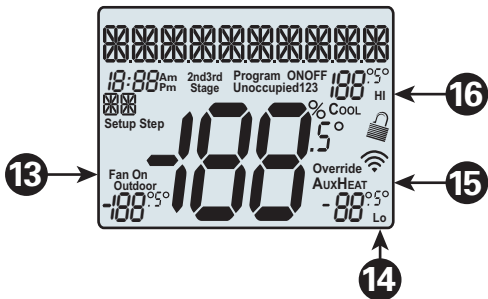

- 13 Fan On icon**—Indicates constant, continuous fan operation. When **Fan On** is not lit - indicates the fan will only operate when necessary to heat or to cool.
- 14 Lo icon**—Indicates the lowest recorded outdoor temperature for the day.\*
- 15 AuxHeat icon**—Indicates 2nd stage electric strip heat is being used when the thermostat is programmed for Heat Pump operation. Only the Aux icon will appear during Cool to Dehumidify to indicate Reheat operation.
- 16 Hi icon**—Indicates the highest recorded outdoor temperature for the day.\*

\* *Hi and Lo Temperatures for the day, reset at midnight.*

# Quick Start

## During Setup and Programming:

Press the **WARMER** or **COOLER** buttons to modify the selection.

Press the **MODE** button to advance and confirm through the setup steps.

## Setting the Clock and Day

*Not available when Wi-Fi module is present*

Press the SET CLOCK button. Adjust the clock using the WARMER or COOLER buttons. Press MODE to advance to the day setting. Adjust the day using the WARMER or COOLER buttons. Press the SET CLOCK button to confirm settings.

NOTE: To adjust the time by hours, press and hold the FAN button while pressing the WARMER or COOLER buttons.



## Selecting the Heat or Cool Mode

Select mode by pressing the **MODE** button.



**Heating Only**—Only the heating operation will be controlled by the thermostat in this mode.

**Cooling Only**—Only the cooling operation will be controlled by the thermostat in this mode.

**Heating or Cooling (Auto-Changeover)**—AUTO will automatically select heat or cool based on room temperature demand.

**OFF**—OFF indicates both heating and air conditioning systems are turned off.

# Quick Start

## Selecting your desired temperature

**AUTO-CHANGEOVER MODE**—Pressing the **WARMER** or **COOLER** buttons in Auto mode will adjust both the heat and cool setpoints simultaneously. To adjust heat and cool setpoints individually, choose **HEAT** mode to adjust the heat setpoint and **COOL** mode to adjust the cool setpoint, then return to **AUTO** mode.

**HEAT OR COOL MODE**—Pressing the **WARMER** or **COOLER** buttons in Heat or Cool mode will adjust only the heat or cool setpoints individually displayed.

## Using the Fan Button

**FAN ON** indicates constant fan operation. **FAN ON** is not allowed when the thermostat is in the **OFF** mode. Pressing the **FAN** button toggles this feature. If you don't see **FAN ON**, the fan is in auto mode and will only turn on during a heat or cool demand. The fan is forced into auto mode when running the program and the thermostat shows **unoccupied**.

## Using the Override Button

OVERRIDE



**NOTE:** Override may only be used when the thermostat is set to **PROGRAM ON**.

**Unoccupied Operation**—During programmed, unoccupied

periods, pressing the **OVERRIDE** button will force the thermostat into Occupied 1 setting for 30 minutes. Each press of the **OVERRIDE** button will add another 30 minutes of time for up to 4 hours. If the maximum time has been set, the next press of the **OVERRIDE** button will reset the timer and return the thermostat to the correct time period program for the day

**Occupied Operation**—During programmed, occupied periods, pressing the **OVERRIDE** button will force the thermostat into an unoccupied period for the rest of the day. During this forced unoccupied period, the **OVERRIDE** button will operate as described above.

# Quick Start

## Viewing the Temperature Sensors

Press **ACCESSRY STATUS** to view the current values of optional outdoor and remote/supply temperature sensors. If connected to a Skyport® account, the temperature for the location you set up in the account will be shown if you don't have a wired sensor connected. The high/low outdoor temperature will also be shown (resets at midnight). Press **MODE** to move between sensors and enter the actual Wi-Fi accessory status section. Setup step #44 selects the use of the wired temperature sensor. Press **ACCESSRY STATUS** again to return to the main screen.

ACCESSRY  
STATUS



## Viewing the Indoor Humidity Sensor

**IMPORTANT: Allow at least 2 minutes after the thermostat is powered on for the humidity to read correctly.**

Press the **HUMIDITY** button, then the mode button to display the current humidity measured at the thermostat. The room's relative humidity is displayed in the top left corner. The humidification setpoint appears in the larger, center display and can be adjusted using the **WARMER** or **COOLER** buttons. Press the **MODE** button again to view and adjust the dehumidification setpoints. Press the **HUMIDITY** or **MODE** button again to confirm settings and return to normal operation.

HUMIDITY



*Note: Due to variations in environmental and equipment conditions, it is not always possible to achieve the desired humidification or dehumidification setpoint.*

# Installation Instructions

## Remove and Replace the Old Thermostat

To install the thermostat properly, please follow these step-by-step instructions. If you are unsure about any of these steps, call a qualified technician for assistance.

- Assemble tools: Flat-blade screwdriver, wire cutters, and wire strippers.
- Make sure your Heater/Air Conditioner is working properly before beginning installation of the thermostat.
- Carefully unpack the thermostat. Save the screws, any brackets, and instructions.
- Turn off the power to the Heating/Air Conditioning system at the main fuse panel. Most residential systems have a separate breaker for disconnecting power to the furnace.
- Remove the cover of the old thermostat. If it does not come off easily, check for screws.
- Loosen the screws holding the thermostat base or subbase to the wall and lift away.
- Use a smart phone or mobile device to take a photo of the wiring for future reference.
- Disconnect the wires from the old thermostat. Tape the ends of the wires as you disconnect them, and mark them with the letter of the terminal for easy reconnection to the new thermostat.
- Keep the old thermostat for reference purposes, until your new thermostat is functioning properly.

# Installation Instructions

## Wire Connections

If the terminal designations on your old thermostat do not match those on the new thermostat, see the chart below or the wiring diagrams that follow.

Wire from the old thermostat terminal marked	Function	Install on the new thermostat connector marked
G or F	Fan	G
Y1, Y	Cooling	Y1
W1, W	Heating	W1/O/B
Rh, R, M, Vr, A	Power	R
C	Common	C
O/B	Rev. Valve	W1/O/B*
W2	2nd Stage Heat	W2
Y2	2nd Stage Cooling	Y2
W3	3rd Stage Heat	W3
H, Hum	Humidity	HUM
D, Dehum	Dehumidity	DEHUM
Ck1	Dry Contact Switch	DRY CONTACT
CKGND	Dry Contact Switch	DRY CONTACT

\* O/B is used if your system is a Heat Pump.

# Installation Instructions

## The Thermostat Backplate

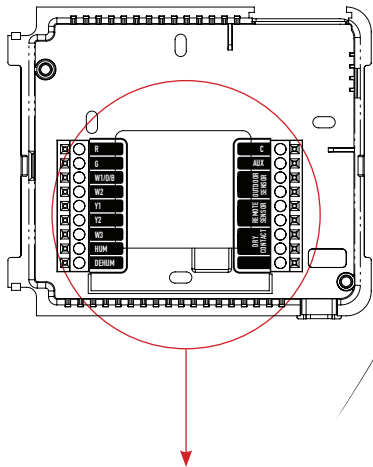

**To remove the thermostat backplate:** Gently separate the display from the base by pulling first from one side, then the other until the two pieces unsnap.

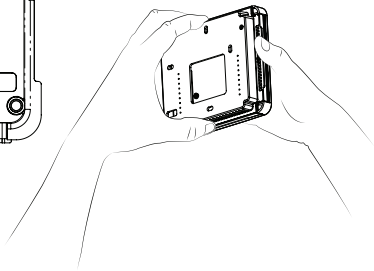

<b>R</b>	24 VAC return	<b>C</b>	24 VAC common
<b>G</b>	Fan relay	<b>AUX</b>	Aux output
<b>W1/O/B</b>	1st stage heat circuit	<b>OUTDOOR SENSOR</b>	Outdoor sensor connections
<b>W2</b>	2nd stage heat circuit	<b>REMOTE SENSOR</b>	Remote sensor connections
<b>Y1</b>	1st stage compressor relay	<b>DRY CONTACT</b>	Dry Contact connections
<b>Y2</b>	2nd stage compressor relay		
<b>W3</b>	3rd stage heat circuit		
<b>HUM</b>	Humidifier control circuit		
<b>DEHUM</b>	Dehumidifier control circuit		

**IMPORTANT:** This thermostat requires connection of both R (24 VAC Return) and C (24 VAC Common) to the backplate terminals.

# Installation Instructions

## Check Dip Switches

Ensure which switch is correct for your system. Dip switches are located on the back of the thermostat.

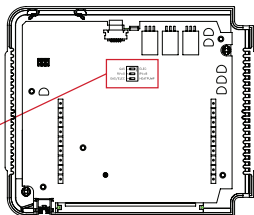
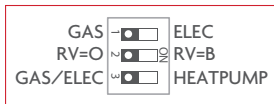

OR



1. When GAS/EL or HP is set for GAS/EL:

This switch (GAS or ELEC) controls how the thermostat will control the Fan (G) terminal in heating mode. When GAS is chosen, the thermostat will not energize the Fan (G) terminal in heating. When ELEC is chosen, the thermostat will energize the fan in heating.

2. When GAS/EL or HP is set for HP:

This switch (GAS or ELEC) defines the Aux Heat type. When GAS is chosen, the auxiliary heat will not be allowed to run during heat pump operation. When ELEC is chosen, up to two stages of auxiliary strip heat will be allowed to run.



OR



For Heat Pump Only

When the GAS/EL or HP dip switch is configured for HP, this dip switch (O or B) must be set to control the appropriate reversing valve. If O is chosen, the W1/O/B terminal will energize in cooling. If B is chosen, the W1/O/B terminal will energize in heating.

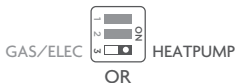

OR



This dip switch configures the thermostat to control a conventional gas/electric system or a heat pump. If your system is anything other than a heat pump, leave this switch set for GAS/EL.



# Installation Instructions

## Sample Wiring Diagrams

### Conventional Heating and Cooling Systems

#### 3 Wire, Heat Only

Residential & Commercial 1 Stage Heating with no Fan.

R 24VAC Power  
C 24VAC Common  
W1/O/B 1st Stage Heat



#### 4 Wire, Cool Only

Residential & Commercial 1 Stage Cooling.

R 24VAC Power  
C 24VAC Common  
Y1 1st Stage Cool  
G Fan



#### 5 Wire, 1 Stage Cooling, 1 Stage Heat

Residential & Commercial 1 Stage Cooling, with 1 stage Gas Heat.

R 24VAC Power  
C 24VAC Common  
W1/O/B 1st Stage Heat  
Y1 1st Stage Cool  
G Fan



#### 5 Wire, 1 Stage Cooling, 1 Stage Heat

Residential & Commercial 1 Stage Cooling, with 1 stage Electric Heat.

R 24VAC Power  
C 24VAC Common  
W1/O/B 1st Stage Heat  
Y1 1st Stage Cool  
G Fan



#### 8 Wire, 2 Stage Cooling, 3 Stage Heat

Residential & Commercial 2 Stage Cooling, with 3 stage Gas Heat.

R 24VAC Power  
C 24VAC Common  
W1/O/B 1st Stage Heat  
W2 2nd Stage Heat  
W3 3rd Stage Heat  
Y1 1st Stage Cool  
Y2 2nd Stage Cool  
G Fan



# Installation Instructions

## Sample Wiring Diagrams

### Heat Pump Systems

#### 5 Wire, 1 Stage Cooling, 1 Stage Heat

Residential & Commercial Heat Pump with  
O Reversing Valve

R	24VAC Power
C	24VAC Common
W1/O/B	Reversing Valve
Y1	1st Stage Compressor (Cool or Heat)
G	Fan



#### 6 Wire, 1 Stage Cooling, 2 Stage Heat

Residential & Commercial Heat Pump with  
O Reversing Valve

R	24VAC Power
C	24VAC Common
W1/O/B	Reversing Valve
Y1	1st Stage Compressor (Cool or Heat)
W2	Aux Heat
G	Fan



#### 7 Wire, 2 Stage Cooling, 3 Stage Heat

Residential & Commercial Heat Pump with  
O Reversing Valve.

R	24VAC Power
C	24VAC Common
W1/O/B	Reversing Valve
W2	3rd Stage Heat
Y1	1st Stage Compressor (Cool or Heat)
Y2	2nd Stage Compressor (Cool or Heat)
G	Fan

Setup Step 31 is set to 2  
(Number of Compressor Stages)



#### 8 Wire, 2 Stage Cooling, 4 Stage Heat

Residential & Commercial Heat Pump with  
O Reversing Valve.

R	24VAC Power
C	24VAC Common
W1/O/B	Reversing Valve
W2	3rd Stage Heat
W3	4th Stage Heat
Y1	1st Stage Compressor (Cool or Heat)
Y2	2nd Stage Compressor (Cool or Heat)
G	Fan

Setup Step 31 is set to 2  
(Number of Compressor Stages)



Note: When the unit goes into 4th stage heating, there is no 4th stage indicator, the display will still show 3rd stage.

# Installation Instructions

## Sample Wiring Diagrams

### Humidification or Dehumidification

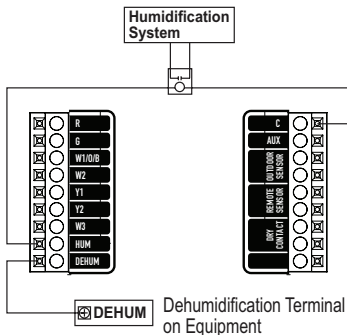

### Dry Contact and Aux Output

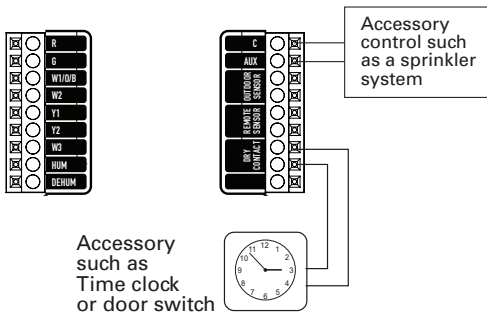

## Installation Instructions: Test Operation

The thermostat has a diagnostic feature that enables testing of all outputs. This feature is contained in the thermostat's **technician setup**.

---

*To enter Technician Setup, press and hold the **SETUP** button for 10 seconds until all the icons appear. Follow the next steps to view settings and test equipment.*

---

1. Press **MODE** to view the version numbers of the thermostat.
2. Press **MODE** again to view the jumper settings and current state of the Dry Contact terminal.
3. Press **MODE** again and the scrolling display will read **TURN ON EQUIPMENT?** Press **WARMER** for Yes or **COOLER** for No.

If Yes is chosen, press **WARMER** to turn on heat or **COOLER** to turn on Cooling. The scrolling display will read **NOTHING ON**. Next:

Press **WARMER** to turn on and cycle up through the heating stages.  
Press **COOLER** to turn the heating stages off. Press **MODE** to exit.

Press **COOLER** to turn on and cycle down through the cooling stages.  
Press **WARMER** to turn the cooling stages off. Press **MODE** to exit.

4. Press **MODE** until **CALIBRATE SENSORS?** appears on the scrolling display. Press **WARMER** for Yes or **COOLER** for No. Press **MODE** to select which sensor to calibrate. Use **WARMER** or **COOLER** to modify your selection.
5. Press **MODE** until **CONTROL HUM?** appears on the scrolling display. Press **WARMER** for On or **COOLER** for Off. Press **MODE** to continue.
6. Press **MODE** until **CONTROL DEHUM?** appears on the scrolling display. Press **WARMER** for On or **COOLER** for Off. Press **MODE** to continue.
7. Press **MODE** until **CONTROL AUX OUT?** appears on the scrolling display. Press **WARMER** for On or **COOLER** for Off. Press **MODE** to exit.

*To exit Technician Setup at any time, press the **SETUP** button. Technician Setup will automatically exit after 10 minutes if no buttons are pressed.*

## User Setup - Backlight Operation

### How to Change Settings in the Setup Screens

To enter Advanced Setup, press the **SETUP** button, then press **MODE**. Use the **WARMER** or **COOLER** buttons to adjust the value of your selection. Press **MODE** to advance to the next setup step. Press **SETUP** again to leave the setup screens.

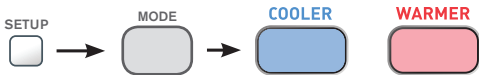

---

### Backlight (setup steps 3-8)

#### Backlight (setup step 3)

**Off** - Backlight turns on with any button press and turns off after 8 seconds.

**On** - Backlight is on continuously.

#### Backlight Level (setup step 4)

The backlight can be adjusted between Off and seven levels of brightness.

**Night Dimmer (setup step 5)** - Selecting **On** allows for automatic dimming of the display at night.

**Night Dimmer Brightness (setup step 6)** The nighttime backlight can be adjusted between OFF and seven levels of brightness.

**Night Dimmer Start Time (setup step 7)** - 12:00 am to 12:00 am

**Night Dimmer Stop Time (setup step 8)** - 12:00 am to 12:00 am

---

### Language (setup step 21)

Setup step instructions on the scrolling display can be set for English, Spanish, or French.

**Press the SETUP button, then press MODE repeatedly until the Language setup step appears. Use the WARMER or COOLER buttons to make selection. Press MODE to advance to the next step. Press SETUP to leave the setup screens.**

# User Setup - Scrolling Screen & Display Options

## Scrolling Display Method (setup step 22)

This option allows the user to choose how the scrolling text is displayed. Options are:

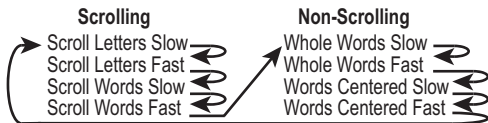

Press the **SETUP** button, then press **MODE** repeatedly until the Scrolling Method setup step appears. Use the **WARMER** or **COOLER** buttons to make selection. Press **MODE** to advance to the next step. Press **SETUP** to leave the setup screens.



Example of "Whole Words Centered":

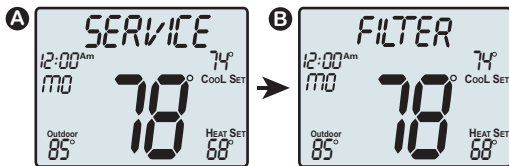

# User Setup

## Holiday

**The Holiday feature allows the thermostat to use temporary, energy saving settings without having to change regular programming.**

HOLIDAY



Holiday setup/programming at the local thermostat is limited to the number of days employing Holiday settings. When the optional Wi-Fi module is detected in the thermostat, local Holiday programming at the thermostat of the Holiday setup is not allowed. In this case Holiday setup and programming is accomplished with the Skyport Web App. Skyport gives the user extensive control over Holiday settings.

Press the HOLIDAY button to enter Holiday programming (no Wi-Fi Module detected).

If there is not a Holiday period active:

Use the WARMER and COOLER buttons to choose the number of days desired to run the Holiday feature. To confirm your setting press the HOLIDAY button again.

When the thermostat is programmed for Holiday operation, and the thermostat is in the Program On mode (running an Occupied/Unoccupied time period schedule), Holiday settings will take effect at 12:00AM of the next day. The thermostat will use the unoccupied mode and setpoints (see page 25) during the holidays.

If the Holiday button is pressed during an active Holiday period:

The active Holiday period may be cancelled by pressing the Mode button.

## Emergency Heat

**The Emergency Heat function is only available if your thermostat is set to control a Heat Pump.**

EMERGENCY  
HEAT



To initiate the Emergency Heat feature, Press the **EMERGENCY HEAT** button. During Emergency Heat operation the thermostat will turn on the fan and auxiliary stages of heat when there is a demand for heat. The 1st stage of heating and all stages of cooling will be unavailable. To exit Emergency Heat, press the **EMERGENCY HEAT** button.

## Wireless Module

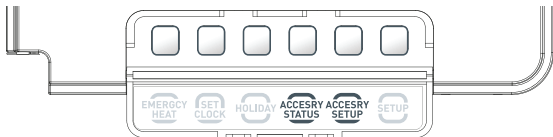

The **ACCESSORY STATUS** button allows the user to view the status of wired and wireless accessories. For many of the wireless devices this status includes: Battery Level, Signal Strength, and Last Time Updated.

If there is an optional wireless module installed, the **ACCESSORY SETUP** button allows the user to link or connect wireless devices to the thermostat, or the thermostat to the network.

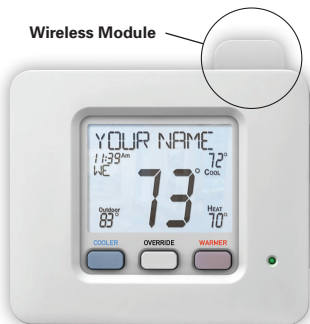



# User Setup

## Wi-Fi Module



Wi-Fi Module



Please follow the instructions included with the Wi-Fi module to connect to an Access Point or view status. The general instructions are below.

## Wi-Fi Module

If the  is present on the display then the thermostat is connected to the Wi-Fi Access Point. If just the "dot" of this icon appears, then just the Wi-Fi module is recognized.

Press the **ACCESSORY STATUS** button, until you see the scrolling message starting with, **PRESS THE WARMER**. After that, press **WARMER** to view the Wi-Fi status/settings or press **COOLER** to view connected Wi-Fi sensors.

Press the **MODE** button to step through the connected sensors or the Wi-Fi status screens listed below.

- Wi-Fi status (connecting, connected, etc.)
- Signal strength
- Access point name
- IP address
- MAC address
- Skyport status (connecting, connected with, etc.)
- Local API status (Enabled, Disabled)
- Module version

• At any time press the **ACCESSORY STATUS** button to leave the status screens.

Press the **ACCESSORY SETUP** button to enter Wi-Fi or Skyport setup:

Press the **COOLER** button to configure Wi-Fi settings.

Press the Warmer button to join this thermostat to a Skyport account. If the thermostat is connected to Wi-Fi and the Internet, a Device ID will appear on the scrolling display of the thermostat. You will enter this code to add this thermostat to your Skyport account via a browser or the Skyport mobile app.

**Note:** To connect to Skyport Cloud Services, Setup Step #71 must be set to on.

## User Setup - Service Filter

These setup steps allow the user to monitor equipment runtimes and program service alerts. Service alerts are displayed in the scrolling marquee.

FAN ON | AUTO



Press and hold FAN to clear service alert messages from the scrolling marquee.

Runtime hours or days appear in the clock display.



## Service Filter Runtime

**Current Service Filter Runtime Hours (Setup Step 9)** - This counter keeps track of the number of hours of fan runtime in the Heating mode, Cooling mode, and in stand-alone Fan operation. Press FAN to reset.

**Current Service Filter Calendar Days (Setup Step 10)** - This counter displays the total number of calendar days that have elapsed since the counter was reset to help the user track Fan runtime. Press FAN to reset.

**Set Service Filter Runtime Hours (Setup Step 17)** - This timer allows the user to specify the number of hours the fan will run before the "Replace Filter" alert will be displayed. Press COOLER continuously until **0** is displayed to disable this alert.

**Set Service Filter Calendar Days (Setup Step 18)** - This timer allows the user to specify the number of calendar days that will elapse before the "Replace Filter" alert will be displayed. Press COOLER continuously until **0** is displayed to disable this feature.

Press the **SETUP** button, then press **MODE** repeatedly until the desired setup step appears. Use the **WARMER** or **COOLER** buttons to make selection. Press **MODE** to advance to the next step. Press **SETUP** to leave the setup screens.



## User Setup - System Runtimes

*To view, set, or reset System Runtimes, press the **SETUP** button, then press **MODE**. Press **MODE** to advance to the desired setup step. Use the **WARMER** or **COOLER** buttons to adjust the value of your selection. Press **SETUP** again to leave the setup screens.*

### Heating and Cooling System Runtime - Energy Watch

**Current Heat Runtime Hours (Setup Step 11)** - This counter keeps track of the number of hours the system has run in Heating. Press **FAN** to reset.

**Current Aux Strip Heat Runtime Hours (Setup Step 12)** - This counter keeps track of the number of hours the system has run in Auxiliary Heating. This setup step is only available when the thermostat jumpers are configured for Heat Pump and Electric Heat. Press **FAN** to reset.

**Current Cool Runtime Hours (setup step 13)** - This counter displays the number of hours the system has run in Cooling. Press **FAN** to reset.

**Current Override Hours (setup step 14)** - This counter keeps track of the number of hours that the thermostat is overridden into Occupied settings. Press **FAN** to reset.

### UV Lamp Runtime

**Current UV Lamp Calendar Days (setup step 15)** - This counter displays the total number of calendar days that have elapsed since last reset to help the user track UV lamp runtime. Press **FAN** to reset.

**Set UV Lamp Calendar Days (setup step 19)** - This timer allows the user to specify the number of calendar days the UV Lamp will operate before the "Replace UV Lamp" alert will be displayed. Press **COOLER** continuously until **0** appears to disable this alert.

### Humidifier Runtime

**Current Humidifier Calendar Days (setup step 16)** - This counter displays the total number of calendar days that have elapsed since last reset to help the user track the Humidifier run-time. Press **FAN** to reset.

**Set Humidifier Calendar Days (setup step 20)** - This timer allows the user to specify the number of calendar days the Humidifier will run before the **Service Humidifier** alert will be displayed. Press **COOLER** continuously until **0** appears to disable this alert.

## User Setup - Time Period Programming

### Selecting Your Time Period Schedule *(setup step 1)*

This thermostat may be configured to be programmable or non programmable.

**7 Day Program** - Allows all seven days to be programmed independently.

**Non Program** - No advanced time period programming available.

**1 Day Program** - Allows one 24 hour day to be programmed. This same schedule will be repeated every day the program is set to run.

**5/1/1 Day Program** - Allows weekdays, Saturday, and Sunday to be programmed independently.

### Selecting Your Available Modes *(setup step 2)*

**Auto-Changeover** - Allows the thermostat to turn on heating or cooling based on room temperature demand. Also allows the manual selection of HEAT only or COOL only and OFF.

**Heat and Cool** - Allows the thermostat to turn on heating or cooling depending on which one has been manually selected. Auto-Changeover is not available when this mode is selected.

**Heat Only** - Allows the thermostat to only turn on HEAT or OFF modes.

**Cool Only** - Allows the thermostat to only turn on COOL or OFF modes.

### Programming a Daily Time Period Schedule\*

*\*not available when Wi-Fi module is present*

To enable (RUN) or turn ON the Time Period Schedule press the Program button momentarily.

To turn Off the Time Period Schedule stored program press this button again.

To alter the Time Period Schedule settings; press & hold this button for 5 seconds until the "Set Program" prompt appears. Modify the settings with the Warmer and Cooler buttons. Use the Mode button to advance through the steps. Press the Program button again to leave the setup screens.

#### **Program Button**

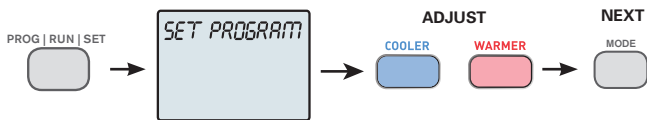

## Programming a Daily Schedule

*Once the Set Program prompt appears the Mode button will step you through the settings as follows:*

**Set the Unoccupied Mode** – Press the Warmer or Cooler buttons to choose the mode for the Unoccupied period. The thermostat is in Unoccupied when the Time Period Schedule is running and there is not an active Occupied period. The choices are: Off, Heat only, Cool only and AUTO changeover.

**Adjust the Unoccupied Cool Setpoint** – Press the Warmer or Cooler buttons to adjust the Cooling setpoint for times when the thermostat is in Unoccupied.

**Adjust the Unoccupied Heat Setpoint** – Press the Warmer or Cooler buttons to adjust the Heating setpoint for times when the thermostat is in Unoccupied.

**Select the number of Occupied time periods** – Press the Warmer or Cooler buttons to choose the maximum number (up to 3 maximum) of Occupied time periods in a day.

**Select the Mode for the Occupied period** – Press the Warmer or Cooler buttons to choose the mode for the occupied period. The choices are: Off, Heat only, Cool only, and AUTO changeover.

**Adjust the Occupied Cool Setpoint** – Press the Warmer or Cooler buttons to adjust the Cooling setpoint for comfort.

**Adjust the Occupied Heat Setpoint** – Press the Warmer or Cooler buttons to adjust the Heating setpoint for comfort.

*The following steps determine when the Occupied period(s) will be active.*

**Enable Occupied 1** – Press the Warmer or Cooler buttons to enable (On) or to disable (Off) Occupied 1 on Monday.

**Adjust the Start Time for Occupied 1** – Press the Warmer or Cooler buttons to adjust the start time for Occupied 1 on Monday.

**Adjust the Stop Time for Occupied 1** – Press the Warmer or Cooler buttons to adjust the stop time for Occupied 1 on Monday.

Upon pressing **MODE** after the above step, you will be prompted to Save and Exit or Copy this Occupied schedule to another day.

**To save and exit** – Press the Program button.

**To Copy Monday's settings/schedule to Tuesday** – Press Up and then Mode. *Press Mode again to copy the Monday Settings/schedule to subsequent days.*

**To Program Another Day** – Press Down and then press the Mode button to select the day to program. Repeat the above steps for each day you would like to program.

# Installer Setup

**Setpoint Limits** (*setup step 23*) When this feature is at any setting other than no setpoint limits', the heat and cool setpoints can be restricted to preset levels, set in steps 24 and 25.

This feature allows the user to set 3 different levels of security: (0 - 3).

**No Setpoint Limits (0)** - When this level is selected, no restrictions are activated.

**Use Setpoint Limits (1)** - When this level is selected, the heat and cool setpoints can be restricted to preset levels, set in setup steps 24 and 25.

**Maximum Heat Setpoint (setup step 24)** - (35° - 99°).

**Minimum Cool Setpoint (setup step 25)** - (35° - 99°).

**Force Program Mode (2)** - When this level is selected, the heat and cool setpoints can be restricted to preset levels, set in setup steps 24 and 25 and the thermostat is locked into the current mode and time period program setting and the FAN button is locked out.

**Setpoints Frozen (3)** - When this level is selected, the heat and cool setpoints, the current mode, the FAN button and time period program settings are locked

**Cycles Per Hour** (*setup step 26*) The Cycles Per Hour setting may limit the number of times per hour your HVAC unit may energize. For example, at a setting of 6 cycles per hour the HVAC unit will only be allowed to energize once every 10 minutes. The Cycles Per Hour limit may be overridden and reset by pressing the WARMER or COOLER buttons on the thermostat. Settings are No Limit, 2, 3, 4, 5, or 6.

**Compressor Minimum Off Minutes** (*setup step 27*) This feature allows the user to set a minimum off time for the compressor. Settings are 5 min, 3 min, or 0 min.

**Minimum Heat/Cool Setpoint Difference** (*setup step 28*)

This feature allows the user to set the minimum gap between Heat and Cool setpoints in **AUTO** mode. Select from 0 to 6. If setup step 2 is not set for **AUTO-CHANGEOVER**, this step will not appear.

**Number of Heat Stages** (*setup step 29*) This setting assures proper stage callouts on the thermostat display for non-heat pump applications.

**Number of Cool Stages** (*setup step 30*) This setting assures proper stage callouts on the thermostat display for non-heat pump applications.

**Number of Compressor Stages** (*setup step 31*) **This feature is for heat pump application only.** This feature allows the thermostat to control 1 or 2 compressor stages when configured for heat pump.

**Number of Aux Stages** (*setup step 32*) This feature is for heat pump application only. This feature allows for proper Aux Heat Staging. (0-2 stages)

# Installer Setup

## Deadband Settings *(setup steps 33 - 42)*

The Deadband is the number of degrees or minutes that the thermostat waits before it initiates the stages of heating or cooling.

**1st Stage Deadband** *(setup step 33)* - Specifies the minimum temperature difference between the room temperature and the desired setpoint before the first stage of heating or cooling is allowed to turn on. (1 - 6 degrees) For example, if the heat setpoint is 68° and the 1st Stage deadband is set to 2 degrees, the room temperature will need to reach 66° before the heat turns on.

**2nd Stage Deadband** *(setup step 34)* - Specifies the additional minimum temperature difference after the first stage turns on before the second stage is activated. (0° - 10°)

**3rd Stage Deadband** *(setup step 35)* - Specifies the additional minimum temperature difference after the second stage turns on before the third stage is activated. (0° - 10°)

**4th Stage Deadband** *(setup step 36)* - **(Two Stage heat pump only)** - Specifies the additional minimum temperature difference after the third stage turns on before the final stage of strip heat is activated. (0° - 10°)

**Minutes Between 1st and 2nd Stage** *(setup step 37)* - Specifies the *minimum* time (in minutes) after the first stage turns on before the second stage can turn on. (0 - 60)

**Minutes Between 2nd and 3rd Stage** *(setup step 38)* - Specifies the *minimum* time (in minutes) after the second stage turns on before the third stage can turn on. (0 - 60)

**Minutes Between 3rd and 4th Stage** *(setup step 39)* - Specifies the *minimum* time (in minutes) after the third stage turns on before the final stage can turn on. (0 - 60)

**Second Stage Turnoff Point** *(setup step 40)* - Specifies whether second stage will turn off at first stage deadband or remain on until the room temperature demand is satisfied. Choose between Deadband or Setpoint.

**Third Stage Turnoff Point** *(Setup Step 41)* - Specifies whether third stage will turn off at second stage deadband or remain on until the room temperature demand is satisfied. Choose between Deadband or Setpoint.

**Fourth Stage Turnoff Point** *(Setup Step 42)* - Specifies whether fourth stage will turn off at third stage deadband or remain on until the room temperature demand is satisfied. Choose between Deadband or Setpoint.

# Installer Setup

## **Minutes of Fan Purge** *(setup step 43)*

When this feature is activated, the fan will turn on during an unoccupied period at a preset amount of time prior to Occupied 1. This preoccupancy fan purge timer may be set from zero to three hours, in 15 minute increments. Zero means this feature is turned off.

## **Fan Off Delay in Seconds** *(setup step 54)*

This feature allows the user to increase the cooling or electric strip heating efficiency of the system. The thermostat may be programmed to continue running the fan after a call for cooling or electric strip heating has been satisfied. This delay can be set for 0, 30, 60, 90, or 120 seconds. If set to 0, the fan will not run after a call for cooling or electric strip heating has been satisfied.

## **Comfort Recovery** *(setup step 65)*

With Comfort Recovery on, the thermostat will attempt to reach the Occupied 1 setpoint temperature at the exact time programmed into the thermostat. Comfort Recovery, only works when the thermostat enters the Occupied mode from the Unoccupied mode. For example, if the Occupied program is set for 6am at 72°F heating and 75°F cooling, the thermostat will turn the system on before 6am in an effort to bring the temperature to its correct setting at exactly 6am. The thermostat learns from experience, so please allow 4-8 days after a program change or after initial installation to give Comfort Recovery time to adjust. If used with a heat pump, electric strip heat will be disabled while Comfort Recovery is active.



# Installer Setup

## **Humidity and Dehumidity** (*setup steps 47-53, 68-70*)

**Humidity Only With Heat (Setup Step 47)** - When this step is set to ON, Humidity will not run without a demand for Heat.

**Fan With Humidity Demand (Setup Step 48)** - Specifies if the fan should be turned on with a demand for Humidity.

**Fan with Dehumidify Demand (Set up Step 49)** - Specifies if the fan should be turned on with a demand for Dehumidify.

**Cool To Dehumidify (Setup Step 50)** - Specifies if the cooling equipment is allowed to turn on exclusively to lower room humidity. (If set to OFF the following two steps will not appear.)

**Max Occupied Dehum Overcool (Setup Step 51)** - Specifies how many degrees below the Cool setpoint the air conditioning will run to satisfy a Cool to Dehumidify demand during occupied periods. (0° - 5°)

**Max Unoccupied Dehum Overcool (Setup Step 52)** - Specifies how many degrees below the Cool setpoint the air conditioning will run to satisfy a Cool to Dehumidify demand during unoccupied periods. (0° to 20°).

**Reheat Operation With Cool To Dehumidify (Setup Step 53)** - Specifies if electric strip heat is allowed to turn on during a Cool to Dehumidify demand to help maintain desired room temperature. This step is not available if Electric Heat is not present.

## **Humidity Polarity** (*setup step 68*)

**Humidity Normally Open** - means no voltage is sent to the HUM output when there is no demand for humidity.

**Humidity Normally Closed** - means voltage is sent to the HUM output when there is no demand for humidity.

## **Dehumidify Polarity** (*setup step 69*)

**Dehumidify Normally Open** - means no voltage is sent to the DEHUM output when there is no demand to dehumidify.

**Dehumidify Normally Closed** - means voltage is sent to the DEHUM output when there is no demand to dehumidify.

## **Dehumidify Only with Cooling** (*setup step 70*)

**When set to ON, Dehumidify will only turn on with a 1st stage cooling demand.**

# Installer Setup

## Dry Contact Operation *(setup step 66 - 67)*

### Dry Contact Polarity *(setup step 66)*

**Open (Normally Open)** - The dry contact is open until the connected device closes the circuit.

**Closed (Normally Closed)** - The dry contact is closed until the connected device opens the circuit.

### Dry Contact Use *(setup step 67)*

**CONDENSATE PAN** - If CONDENSATE PAN is selected when the dry contact is active, the thermostat will lockout the compressor terminal(s) and "CONDENSATE PAN OVERFLOW" will appear on the display.

**OCCUPIED** - If OCCUPIED is selected, when the dry contact is active, the thermostat will be forced into the programmed occupied mode / setpoints and the 'occupied' icon will blink. This setting is useful for allowing a twist timer to force occupied settings.

**FDD** - If FDD is selected when the dry contact is active, "EQUIPMENT FAULT" will appear on the display.

**HOLIDAY** - If HOLIDAY is selected, when the dry contact is active, the thermostat will be forced into the programmed unoccupied mode / setpoints and the 'unoccupied' icon will blink.

**DOOR SWITCH** - If DOORSWITCH is selected, when the dry contact is active for more than 3 minutes, the thermostat set points will switch to OF (off), the equipment will turn off, and **DOOR OPEN** will appear on the display.

## Skyport *(setup step 71)*

Set to ON to allow access to Skyport services or to OFF to not allow access to Skyport services.

## Local API *(setup step 72)*

Set to ON to allow third-party software to interface with your thermostat such as home automation software.

## Wired Sensor Type *(setup step 44)*

Specifies the use of the connected, wired sensor. The choices are: Remote, Supply, Outdoor. Only the remote option allows control of the sensor.

*(continued on next page)*

# Installer Setup

*(continued from previous page)*

## **Control To Temp Source** *(setup step 45)*

This feature allows the user to specify which temperature sensor source(s) to be used to measure room temperature for control

**Thermostat:** Uses the internal thermostat sensor only.

**Wired Remote:** Uses external temperature sensor wired to the REMOTE/ OUTDOOR contacts.

**Wireless Remote:** Uses one wireless remote temperature sensor. Choose which linked sensor to use in the subsequent step.

**Average of Wireless Remotes:** Averages the temperatures of all linked wireless remote sensors.

**Average Thermostat and Wired Remote:** Averages the temperatures of the wired remote sensor and the thermostat.

**Average All Sensors:** Averages the temperatures of the wired remote, any linked wireless remotes and the thermostat.

## **Wireless Remote To Use** *(setup step 46)*

Specifies which single wireless remote sensor is to be used for control. This step only appears when prior step setting is **Wireless Remote**.

## **Fahrenheit or Celsius** *(setup step 55)*

This feature allows the thermostat to display temperature in Fahrenheit or Celsius.

# Installer Setup

## Auxiliary Output

The thermostat is equipped with a programmable auxiliary output. This output can be configured to be controlled from a variety of sources.

### Aux Output Polarity (*setup step 56*)

Specifies if the Auxiliary output will be Open (Normally Open) or Closed (Normally Closed).

### Aux Output (*setup step 57*)

Specifies which source will control the Aux output.  
Choices are:

**Time** - Uses the internal clock of the thermostat.

**Temp** - Uses one of three temperature sources.

**External** - The Auxiliary Output is controlled from an external source, such as a mobile app.

**Economizer** - Used to control an economizer, the Aux Output is active when program is in any occupied time.

## Auxiliary Output Programming By Time

**If TIME is selected for the Aux Output, the following setup steps will appear:**

**Aux Output Program Days (setup step 58)** - Specifies if the Aux Output will be single day (1 DAY), weekday/weekend (5/1/1 DAY), or seven day (7 DAY) programmable.

**Day Of Week To Program (setup step 59)** - Specifies which day of week to program.

**Aux Output Start Time (setup step 60)** - Specifies the time of each day when the Aux output will turn on.

**Aux Output Stop Time (setup step 61)** - Specifies the time of each day when the Aux output will turn off.

**Copy (setup step 62)** - This step only appears if Aux Output Days (Setup Step 58) is set for 7 programmable output days. Press COOLER and then the FAN button to copy. Press WARMER and then the FAN button to program another day with a different setting.

# Installer Setup

## Auxiliary Output Programming By Temp

If **TEMP** is selected for the Aux Output, the following setup steps will appear:

**Aux Output Temp Source (setup step 63)** - Specifies what temperature source will be monitored for controlling the programmable output. The options are:

**Thermostat** - Temperature is monitored from the thermostat sensor.

**Outdoor Sensor** - Temperature is monitored from the Outdoor temperature sensor.

**Wired Remote** - Temperature is monitored from a wired sensor connected to the Remote Sensor terminals.

**Aux Output Trigger Point Temp (setup step 64)** - Specifies the temperature from the above selected source **above** which the Aux Output is triggered. A non-adjustable two degree deadband is applied to avoid frequent triggering. The 'N.O.' (Normally Open) or 'N.C.' (Normally Closed) function (Setup Step 56) can be altered to make the output trigger **below** the set temperature. Temps are adjustable from 0 - 120 degrees Fahrenheit.

## Press Fan To Clear All Messages (setup step 81)

This feature allows the user to clear all current error messages from the display.

## Overview

Source 1 thermostats support the handling of specific signals from the utility provider. The utility generated signals carry pricing information, and setback actions, that alter the comfort settings of the thermostat in order to reduce energy usage on demand. This is known as Automated Demand Response (ADR). You must register to participate in a utility sponsored program, if offered by your local utility, to take advantage of this feature.

## Skyport Cloud Services

From the web application the user will select Thermostat Settings from the left column. Then the Demand Response button is selected.

The screenshot displays the 'Office - Configuration' window. On the left is a vertical menu with the following items: Profile (Rename your thermostat or change its location), Runtime Data (View Heat & Cool runtimes), Sensors (View sensors connected this thermostat), Notifications (Quickly add and remove thermostats notifications), Alerts (View current alerts for this thermostat), Schedule (Modify your thermostat schedule), and Thermostat Settings (Change your thermostat settings). The 'Thermostat Settings' item is highlighted. Below the menu is a 'Delete Thermostat' button. The main content area is titled 'Thermostat Settings' and contains the instruction 'Modify your thermostat settings and preferences.' It features a grid of icons: Preferences (laptop with charts), Alerts (warning triangle with exclamation mark), Holiday (umbrella on a plate), Security (padlock), Humidity (water droplets), Settings (gears), and Demand Response (power line tower).

# Installer Setup - Automated Demand Response

The Demand Response configuration page, shown below, is where the thermostat is configured to respond to the energy provider's signals. It also sets operational parameters for the thermostat.

The left column of the ADR configuration page allows or prevents access by the utility. Here communication with the utility and your thermostat may be turned On or Off.

Office - Configuration

**Profile**  
Rename your thermostat or change its location.

**Runtime Data**  
View Heat & Cool runtimes.

**Sensors**  
View sensors connected to this thermostat.

**Notifications**  
Quickly add and remove thermostats notifications.

**Alerts**  
View current alerts for this thermostat.

**Schedule**  
Modify your thermostat schedule.

**Thermostat Settings**  
Change your thermostat settings.

Delete Thermostat

### Automated Demand Response

Configuration Overview

#### Demand Response

ON  OFF

What is Demand Response?

It is a way for energy suppliers to automatically reduce load during high energy use periods. This reduces the strain on the powergrid while offering incentives to individuals who participate in demand response events.

#### Min & Max Settings

Event Max Cool Setpoint: 89° F	Event Min Heat Setpoint: 83° F
-----------------------------------	-----------------------------------

#### Static Settings

Static Cool Setpoint: 77° F	Static Heat Setpoint: 83° F
--------------------------------	--------------------------------

#### Offset Settings

Cool Setpoint Offset: +2	Heat Setpoint Offset: -3
-----------------------------	-----------------------------

#### Price Settings

Price Trigger  
\$ 0.5

Dependent Action  
Observe Setpoint Offsets

Cancel Save

# Installer Setup - Automated Demand Response

Selecting the Overview tab of the ADR page will cause a summary of ADR events to be displayed.

Office - Configuration

**Profile**  
Rename your thermostat or change its location.

**Runtime Data**  
View Heat & Cool runtimes.

**Sensors**  
View sensors connected to this thermostat.

**Notifications**  
Quickly add and remove thermostats notifications.

**Alerts**  
View current alerts for this thermostat.

**Schedule**  
Modify your thermostat schedule.

**Thermostat Settings**  
Change your thermostat settings.

Delete Thermostat

### Automated Demand Response

Configuration Overview

Event Type	Status	Start Time	Stop Time
Standard	Success	7/11/2018, 5:30:00 PM	7/11/2018, 7:30:00 PM
Standard	Success	9/1/2017, 2:00:00 PM	9/1/2017, 6:00:00 PM
Standard	Success	8/31/2017, 2:00:00 PM	8/31/2017, 6:00:00 PM
Standard	Success	8/30/2017, 2:00:00 PM	8/30/2017, 6:00:00 PM
Standard	Success	8/29/2017, 2:00:00 PM	8/29/2017, 6:00:00 PM
Standard	Success	8/28/2017, 2:00:00 PM	8/28/2017, 6:00:00 PM
Standard	Success	9/14/2018, 2:00:00 PM	9/14/2018, 6:00:00 PM

Cancel Save ✓



### **ADR (setup step 73)**

Controls whether you want the thermostat to possibly respond to signals from the utility provider. Select ON to allow this and to have steps 74-80 appear.

### **ADR Action (setup step 74)**

Allows the user to determine what action is taken when an ADR event is received.

**Observe Setpoint Offsets** – will offset the heat and cool setpoints by the amounts specified in setup steps 79 and 80

**Observe Static Setpoints** – will set the heat and cool setpoints to the values specified in setup steps 77 and 78

### **Event Max Cool Setpoint (setup step 75)**

### **Event Min Heat Setpoint (setup step 76)**

Specifies the range of allowable setpoint adjustments to be enforced when any ADR signal has been received from the utility. Since you might be paying more for energy while an event is active, you can impose tighter limits on setpoint ranges that are only enforced during the event.

### **Static Cool Setpoint (setup step 77)**

### **Static Heat Setpoint (setup step 78)**

Specifies the setpoints that will come into use during an event when the ADR ACTION is set to OBSERVE STATIC SETPOINTS

### **Cool Setpoint Offset** *(setup step 79)*

### **Heat Setpoint Offset** *(setup step 80)*

Specifies how much the current setpoints in effect prior to an event will be altered during an event when the ADR ACTION is set to OBSERVE SETPOINT OFFSETS. The heat setpoint can be automatically lowered by -1 to -10 degrees while the cool setpoint can be automatically raised by 1 to 10 degrees.

### **DISPLAY INDICATIONS WHEN AN ADR EVENT IS HAPPENING**

After setting your desired values for use during an ADR event, the scrolling display will give a little information when an event is pending or active. For instance, when an ADR event has been sent to your thermostat, you might see ADR STARTS 8/14 at 2:00pm to notify you of a pending event. Once active, you might see ADR STOPS 8/14 at 6:00pm. When an event is active, you can press any of COOLER, WARMER or MODE buttons, followed by the WARMER to opt out of the event.

# Installer Setup

## Locking/Unlocking the Keypad

To prevent unauthorized use of the thermostat, the front panel buttons may be disabled. To disable, or 'lock' the keypad, press and hold the MODE button. While holding the MODE button, press the WARMER and COOLER buttons together. The  icon will appear on the display, then release the buttons.

Press all three buttons in the order outlined above for keypad lockout

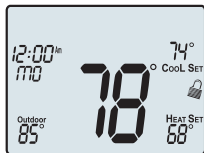

To **unlock** the keypad, press and hold the MODE button. While holding the MODE button, press the WARMER and COOLER buttons together. The  icon will disappear from the display, then release the buttons.

# Installer Setup

## Resetting the Thermostat to the Factory Default Settings (for default values see page 42-44)

If, for any reason, you desire to return all the stored settings back to the factory default settings, follow the instructions below.

**WARNING: This will reset all Time Period and Advanced Programming to the default settings. Any information entered prior to this reset may be permanently lost.**

- 1 Press and hold SETUP for 10 seconds. All icons will appear on the display.

Keep pressing the SETUP button until you see this screen.

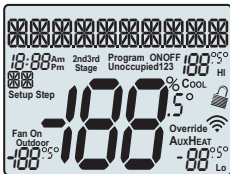

- 2 After all the icons appear, release SETUP. Press and hold FAN for 5 seconds. DEFAULTS will appear on the display.

Keep pressing the FAN button until you see this screen.

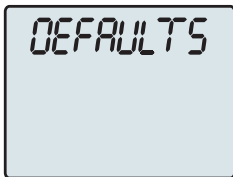

- 3 After DEFAULTS appears, release FAN. Press SETUP to return to normal operation.



# Technician Setup

To enter *Technician Setup*, press and hold the **SETUP** button for 10 seconds. After all the icons appear, press **MODE**. The version number of the thermostat will appear in the scrolling text. Press **MODE** to advance to the next step. Use the **WARMER** or **COOLER** buttons to adjust the value of your selection. To leave *Technician Setup*, press **SETUP**.

Hold for 5 seconds

All icons appear

Press **MODE** to advance through the setup steps

SETUP

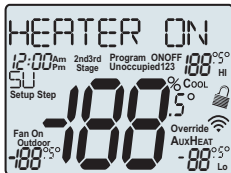

MODE



Press **WARMER** or **COOLER** to adjust the selection

COOLER



MODE



WARMER



**Technician Setup is for diagnostic and testing purposes and is intended for use by a qualified technician. See page 16 for more detailed instructions.**

**Technician Setup contains the following options:**

- View the version number of the thermostat.
- View the Dip Switch equipment type settings.
- View the state of the Dry Contact.
- Turn on equipment outputs for testing.
- Calibrate thermostat, remote, and humidity sensors.
- Control HUM output (On or Off)
- Control DEHUM output (On or Off)
- Control AUX output (On or Off)

# Advanced Setup Table

Default = Factory Default Setting

Step#	Description	Pg#	Range	Default
1	Prog Mode	24	Non, 1 Day, 5/1/1 Day, 7	Day 7
2	Available Modes	24	Heat/Cool/Auto/Off, Heat/Cool/Off, Heat/Off, Cool/Off	Heat/Cool/ Auto/Off
3	Backlight	17	On, Off	Off
4	Backlight Level	17	Off thru 7 levels of brightness	Level 5
5	Night Dimmer	17	On/Off	Off
6	Night Dimmer Brightness	17	Off thru 7 levels of brightness	2 (20%)
7	Night Dimmer Start Time	17	12A-12A	8:00P
8	Night Dimmer Stop Time	17	12A-12A	6:00A
9	Current Service Filter Runtime Hours	22	0-1999 Hours	0
10	Current Service Filter Calendar Days	22	0-720 Days	0
11	Current Heat Runtime Hours	23	0-1999 Hours	0
12	Current Aux Strip Heat Runtime Hours	23	0-1999 Hours	0
13	Current Cool Runtime Hours	23	0-1999 Hours	0
14	Current Override Hours	23	0-1999 Hours	0
15	Current UV Lamp Calendar Days	23	0-720 Days	0
16	Current Humidifier Calendar Days	23	0-720 Days	0
17	Set Service Filter Runtime Hours	22	0-1950 hours	0
18	Set Service Filter Calendar Days	22	0-720 Days	0
19	Set UV Lamp Calendar Days	23	0-720 Days	0
20	Set Humidifier Calendar Days	23	0-720 Days	0
21	Language	17	English, Espanol, Francais	English
22	Scrolling Method	18	"L-R Slow, L-R Fast, Word L-R Slow, Word L-R Fast, Whole Word L Slow, Whole Word R Slow, Whole Word Ctr. Fast, Whole Word Ctr. Slow"	"Whole Words Center Fast"
23	Setpoint Limits	26	0 - 3	0
24	Max Heat Setpoint	26	35 - 99 Degrees	74
25	Min Cool Setpoint	26	35 - 99 Degrees	70
26	Cycles Per Hour	26	No Limit, 2, 3, 4, 5, 6	6
27	Compressor Minimum Off Min.	26	0, 3, 5 Minutes	5
28	Min. Heat/Cool Setpoint Difference	26	0 - 6 Degrees	2
29	Number of Heat Stages	26	0 - 3	2
30	Number of Cool Stages	26	0 - 2	1
31	Number Of Compressor Stages	26	1, 2	1
32	Number of Aux Stages	26	0, 1, 2	0
33	1st Stage Deadband	27	1 - 6 Degrees	2
34	2nd Stage Deadband	27	0 - 10 Degrees	2
35	3rd Stage Deadband	27	0 - 10 Degrees	2

# Advanced Setup Table

Default = Factory Default Setting

Step#	Description	Pg#	Range	Default
36	4th Stage Deadband	27	0 - 10 Degrees	2
37	Minutes Between 1st and 2nd Stage	27	0 - 60 Minutes	2
38	Minutes Between 2nd and 3rd Stage	27	0 - 60 Minutes	2
39	Minutes Between 3rd and 4th Stage	27	0 - 60 Minutes	2
40	2nd Stage Turnoff Point	27	Deadband, Setpoint	Deadband
41	3rd Stage Turnoff Point	27	Deadband, Setpoint	Deadband
42	4th Stage Turnoff Point	27	Deadband, Setpoint	Deadband
43	Minutes of Fan Purge	28	0 - 3:00, 15 min. increments - 0 = off	0
44	Wired Sensor Type	30	Remote, Supply & Outdoor	Remote
45	Control to Temp Source	31	Thermostat, Wired Remote*, Wireless Remote, Average of Wireless Remotes, Average Thermostat and Wired Remote*, Average All Sensors. *Option only if prior step = "Remote"	Thermostat
46	Wireless Remote to Use	31	list of wifi sensors currently linked to thermostat. *This step only appears if prior step = "Wireless Remote"	first linked sensor in list
47	Humidity Only With Heat	29	On, Off	Off
48	Fan With Humidity Demand	29	Fan On, Fan Off	Fan Off
49	Fan With Dehumidify Demand	29	Fan On, Fan Off	Fan Off
50	Cool To Dehumidify	29	On, Off	Off
51	Maximum Occ Dehum Overcool	29	0 - 5 Degrees	2
52	Maximum Unocc Dehum Overcool	29	0 - 20 Degrees	2
53	Reheat Operation W/Cool To Dehum.	29	On, Off	Off
54	Fan Off Delay	28	0 - 120 Seconds	0
55	F/C	31	Fahrenheit (F), Celsius (C)	F
56	Aux Output Polarity	32	Open, Closed	Open
57	Aux Output	32	Time, Temperature, External, Economizer	Time
58	Aux Output Program Days	32	1 Day, 5/1/1 Day, 7 Day	1
59	Day Of Week To Program	32	Sunday - Monday (S - M)	MTWTFSS
60	Aux Output Start Time	32	12am - 12am	7am
61	Aux Output Stop Time	32	12am - 12am	9pm
62	Copy	32	Yes, No	No
63	Aux Output Temp Source	33	Thermostat, Outdoor, Remote	Remote
64	Aux Output Trigger Point Temp	33	0 - 120 Degrees	65
65	Comfort Recovery	28	On, Off	Off

# Advanced Setup Table

Default = Factory Default Setting

Step#	Description	Pg#	Range	Default
66	Dry Contact Polarity	30	Open, Closed	Open
67	Dry Contact Use	30	Condensate Pan, Occupied, FDD, Holiday, Door Switch	
68	Humidity Polarity	29	Open, Closed	Open
69	Dehumidify Polarity	29	Open, Closed	Open
70	Dehumidify only with Cooling	29	On, Off	On
71	Skyport	30	On, Off	On
72	Local API	30	On, Off	Off
73	ADR	37	On, Off	On
74	ADR Action	37	Observe Setpoint Offset, Observe Static Setpoints	Observe Setpoint Offsets
75	Event Max Cool Setpoint	37	35 - 99	90
76	Event Min Heat Setpoint	37	35 - 99	50
77	Static Cool Setpoint	37	35 - 99	82
78	Static Heat Setpoint	37	35 - 99	60
79	Cool Setpoint Offset	38	1 to 10	4
80	Heat Setpoint Offset	38	-1 to -10	-4
81	Press Fan To Clear All Messages	33		



# Troubleshooting

- **SYMPTOM:** The air conditioning does not attempt to turn on.  
**CAUSE:** The compressor timer lockout may prevent the air conditioner from turning on for a period of time.  
**REMEDY:** Consult the Owner's Manual in the Installer Setup section to defeat the Cycles Per Hour (*page 26*).
- **SYMPTOM:** The display is blank.  
**CAUSE:** Lack of proper power.  
**REMEDY:** Make sure the power is on to the furnace and that you have 24vac between **R & C**.
- **SYMPTOM:** The air conditioning does not attempt to turn on.  
**CAUSE:** The cooling setpoint is set too high.  
**REMEDY:** Lower the cooling setpoint or lower the cooling set-point limit. *See Setpoint Limits (page 26)*.
- **SYMPTOM:** The heating does not attempt to turn on.  
**CAUSE:** The heating setpoint is set too low.  
**REMEDY:** Raise the heating setpoint or raise the heating set-point limit. *See Setpoint Limits (page 26)*.
- **SYMPTOM:** When controlling a residential heat pump, and asking for cooling, the heat comes on.  
**CAUSE:** The thermostat reversing valve jumper is set for **B**.  
**REMEDY:** Set the reversing valve jumper for **O**.
- **SYMPTOM:** When calling for cooling, both the heat and cool come on.  
**CAUSE:** The thermostat equipment jumper is configured for **HP** and the HVAC unit is a Gas/Electric.  
**REMEDY:** Set the equipment jumper for **Gas**.
- **SYMPTOM:** When the Program button is pressed, the display reads "DISABLED".  
**CAUSE:** Program mode is set to **NON PROGRAM**.  
**REMEDY:** Set Program Mode (Setup 1) to 1, **5/1/1**, or **7 Day**. *See Selecting Your Program Mode (page 24)*.

# Warranty

**One-Year Warranty** - This Product is warranted to be free from defects in material and workmanship. If it appears within one year from the date of original installation, whether or not actual use begins on that date, that the product does not meet this warranty, a new or remanufactured part, at the manufacturer's sole option to replace any defective part, will be provided without charge for the part itself provided the defective part is returned to the distributor through a qualified servicing dealer.

**THIS WARRANTY DOES NOT INCLUDE LABOR OR OTHER COSTS** incurred for diagnosing, repairing, removing, installing, shipping, servicing or handling of either defective parts or replacement parts. Such costs may be covered by a separate warranty provided by the installer.

**THIS WARRANTY APPLIES ONLY TO PRODUCTS IN THEIR ORIGINAL INSTALLATION LOCATION AND BECOMES VOID UPON REINSTALLATION.**

**LIMITATIONS OF WARRANTIES – ALL IMPLIED WARRANTIES (INCLUDING IMPLIED WARRANTIES OF FITNESS FOR A PARTICULAR PURPOSE AND MERCHANTABILITY) ARE HEREBY LIMITED IN DURATION TO THE PERIOD FOR WHICH THE LIMITED WARRANTY IS GIVEN. SOME STATES DO NOT ALLOW LIMITATIONS ON HOW LONG AN IMPLIED WARRANTY LASTS, SO THE ABOVE MAY NOT APPLY TO YOU. THE EXPRESSED WARRANTIES MADE IN THIS WARRANTY ARE EXCLUSIVE AND MAY NOT BE ALTERED, ENLARGED, OR CHANGED BY ANY DISTRIBUTOR, DEALER, OR OTHER PERSON WHATSOEVER.**

**ALL WORK UNDER THE TERMS OF THIS WARRANTY SHALL BE PERFORMED DURING NORMAL WORKING HOURS. ALL REPLACEMENT PARTS, WHETHER NEW OR REMANUFACTURED, ASSUME AS THEIR WARRANTY PERIOD ONLY THE REMAINING TIME PERIOD OF THIS WARRANTY.**

**THE MANUFACTURER WILL NOT BE RESPONSIBLE FOR:**

1. Normal maintenance as outlined in the installation and servicing instructions or owner's manual, including filter cleaning and/or replacement and lubrication.
2. Damage or repairs required as a consequence of faulty installation, misapplication, abuse, improper servicing, unauthorized alteration or improper operation.
3. Failure to start due to voltage conditions, blown fuses, open circuit breakers or other damages due to the inadequacy or interruption of electrical service.
4. Damage as a result of floods, winds, fires, lightning, accidents, corrosive environments or other conditions beyond the control of the Manufacturer.
5. Parts not supplied or designated by the Manufacturer, or damages resulting from their use.
6. Manufacturer products installed outside the continental U.S.A., Alaska, Hawaii, and Canada.
7. Electricity or fuel costs or increases in electricity or fuel costs for any reason whatsoever including additional or unusual use of supplemental electric heat.
8. ANY SPECIAL INDIRECT OR CONSEQUENTIAL PROPERTY OR COMMERCIAL DAMAGE OF ANY NATURE WHATSOEVER. Some states do not allow the exclusion of incidental or consequential damages, so the above may not apply to you.

This warranty gives you specific legal rights and you may also have other rights which may vary from state to state.

# Technical Specifications

## S1-TBSU306-S Thermostat Controllers

Power Requirements	20 - 30 VAC 50/60 Hz, 3.0 VA @ 24V nominal.	
Output Rating	W1, W2, W3 = 0.2A max, 0.01A min, 3A inrush, 20 - 30 VAC Y1, Y2, G = 0.4A max, 0.01A min, 3A inrush, 20 - 30 VAC HUM, DEHUM, AUX = 0.1A max, 0.01A min, 3A inrush, 20 - 30 VAC	
Local Temperature Sensor Type	Thermistor, NTC 10K @ 25°C	
Remote Temperature Sensor Type	Thermistor, NTC 10K @ 25°C	
Wire Size	16 AWG (100 ft max) to 24 AWG (36 ft max)	
Temperature Adjustment Range	35° to 99° deg F (2° to 36° deg C)	
Accuracy	35° to 65° deg F +/- 3° degF, greater than 65° to less than 80 degF +/- 2 degF, 80° to 99° deg F +/- 3° degF, greater than 99° to 104° deg F +/- 5° deg F	
Humidity	+/- 10% RH from 30-70% RH, 50° - 90° F	
Deadband	Adjustable 1° to 6° deg first stage, 0° - 10° deg 2nd & 3rd stages	
Ambient Conditions	Operating	35° to 104° deg F (2° to 40° deg C), 5 - 95% RH non-condensing, 86° deg F max dew point
	Storage	-22° to 122° deg F (-30° to 50° deg C), 5-95% RH non-condensing, 86° deg F max dew point
Compliance	UL/cUL listed, file E107041, NEC Class 2	
Dimensions	4.4" H x 5.2" W x 1.0"D	
Shipping Weight	0.34 kg	

Patent Pending

88-1347 rev. 3 07/19

